

FIZ 1

The water dispenser that turns your kitchen taps into a sparkling and still filtered BE WTR station.

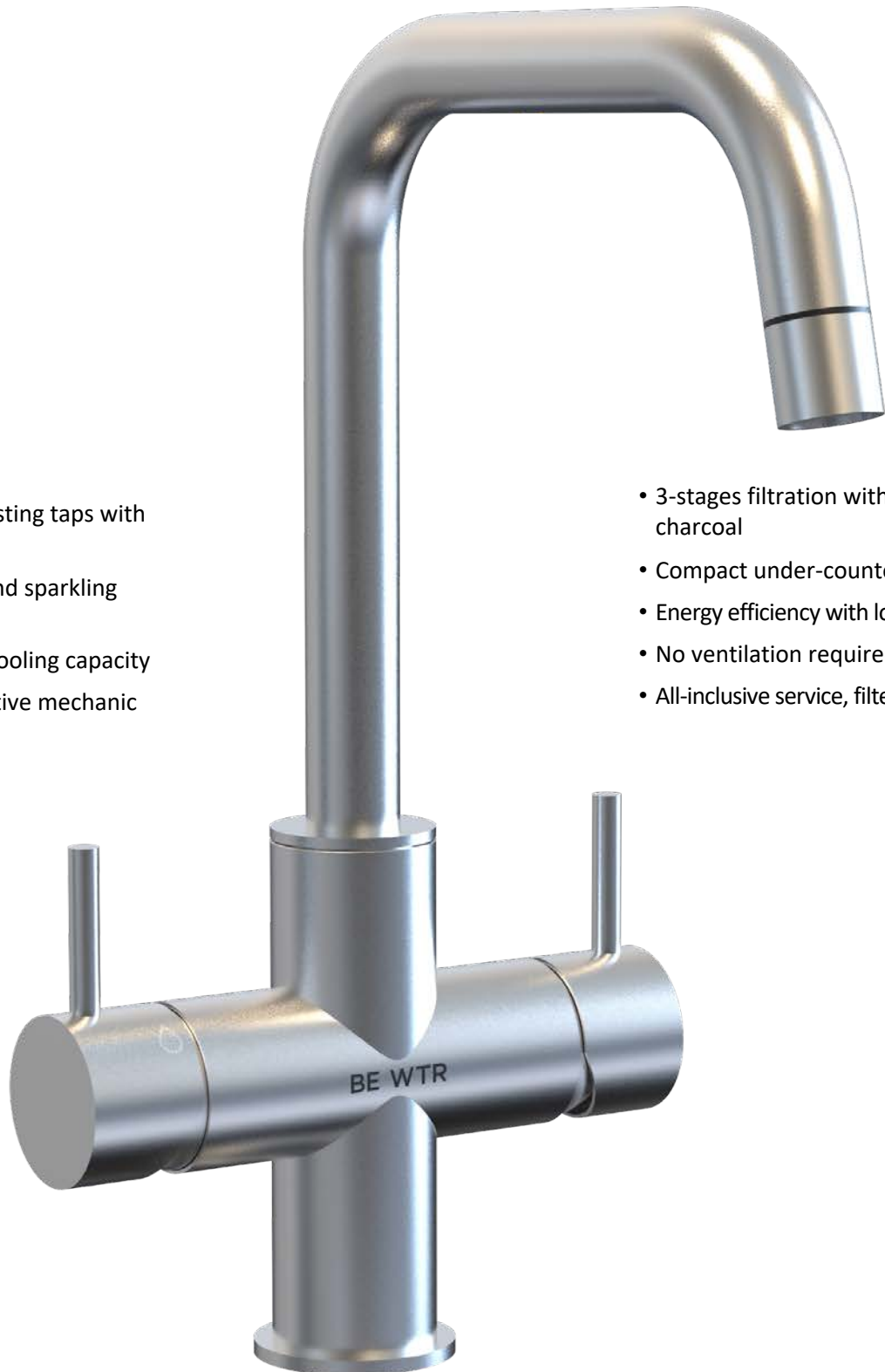



- Elegantly replaces existing taps with integrated unit
- Filtered chilled, still and sparkling water
- 15 litres per hour of cooling capacity
- Ease of use with intuitive mechanic lever design

- 3-stages filtration with activated charcoal
- Compact under-counter unit
- Energy efficiency with low consumption
- No ventilation required
- All-inclusive service, filters & CO2

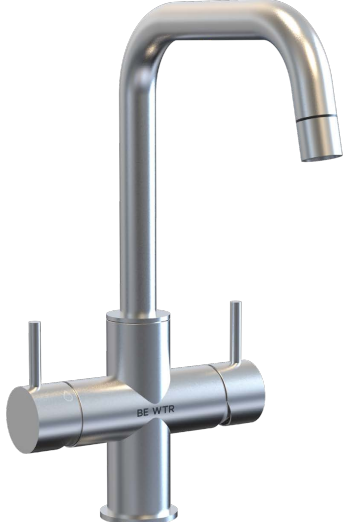

TAP

Water	Chilled filtered, chilled filtered sparkling, cold water	 	
Dimensions	↔18,2, ↓ 35,6, ⬆23,0 cm		
Dispensing height	↓ 26,7 cm		

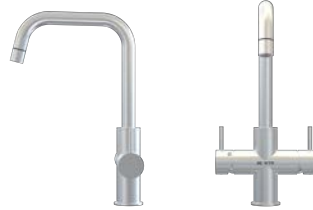







FILTER

Activated Carbon Technology	<p>3-stages filtration with activated charcoal:</p> <ul style="list-style-type: none"> ▪ Coarse particles filtration ▪ Removal of chlorine, organic substances and “off-flavour” components ▪ Fine particles and suspended solids filtration <p>Ultrafiltration with up to 99,9999% particles removal and bacteria protection.</p>	



UNIT

Cooling capacity	Standard 15 l/h	 <p>  Tap  CO2  Filtered chilled Still Water   Filtered chilled Sparkling Water  </p>
Settings	Adjustable temperature and sparkling intensity	
Dimensions	↔24, ↓ 42, ⬆39,8 cm	
Weight	15 kg	
Max. Power	230 W	

SERVICE & MAINTENANCE

All inclusive, twice a year	Full hygiene and safety covering, CO2 and filter replacement, maintenance and lifetime warranty. 100% recycled consumables.
-----------------------------	---

